



# Assembly Instructions

**HY105R** Oval Multi-Stand with One Curving Right Extension

**HY105L** Oval Multi-Stand with One Curving Left Extension

**HY106** Oval Multi-Stand with One Straight Extension

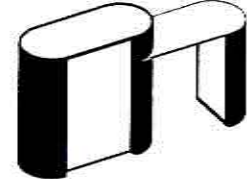
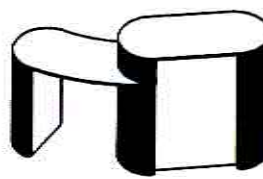
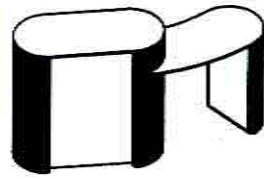
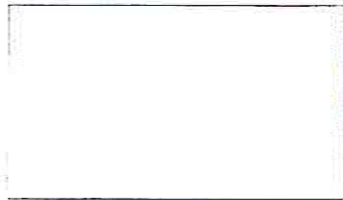

*Note: Above cabinets are made with essentially the same parts. Follow the instructions to assemble your cabinet.*

**1.** Lay bottom cleat (B) on floor. Beginning at start line in bottom cleat (notch in center), wrap tallest flexible shell (SH) tightly around bottom cleat.

**2.** Position top leg form in upper edge of tallest flexible shell to complete leg.

**3.** Repeat steps 1 and 2 to complete two shorter legs.

**4.** Position extension (LE or RE) on two shorter legs.

**5.** Velcro brace panel (BP) in between tallest leg and shorter leg at straight edge of extension.

**6.** Wrap smallest flexible shell to create riser, and place over straight edge of extension.

**7.** Position top (T) to complete the unit.

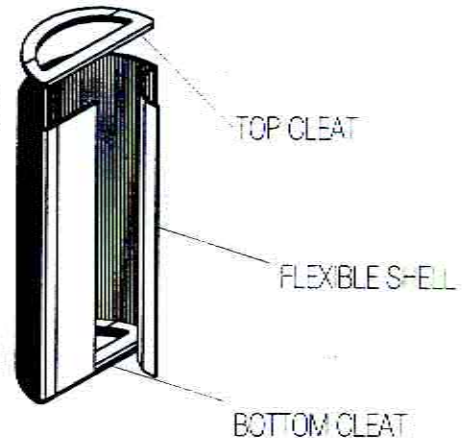

EXTENSION

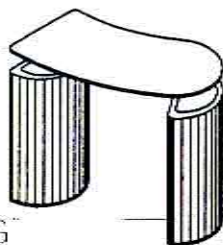

SHORTER LEG

TALLEST LEG

BRACE PANEL

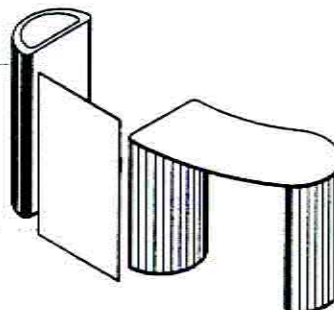

TOP

RISE

